

SIDE VIEW

INSIDE ELEVATION

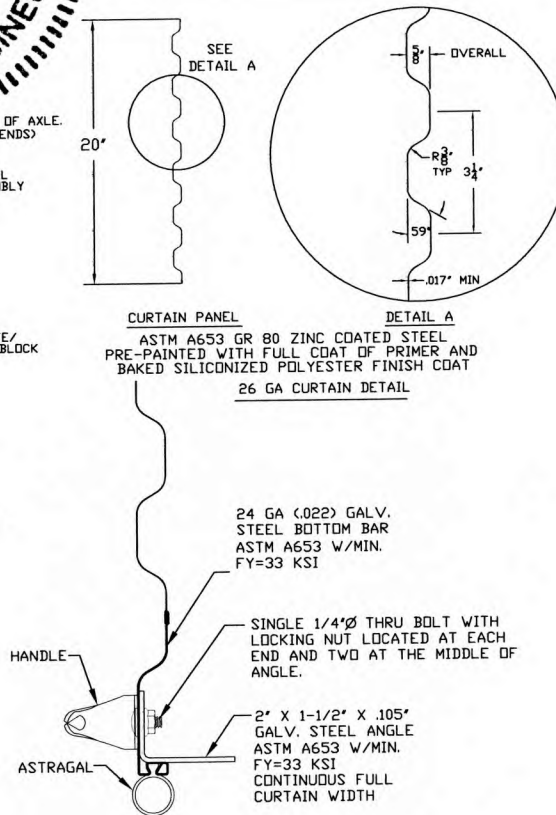

BOTTOM BAR ASSEMBLY

REVISIONS			
REV	DESCRIPTION	DATE	APPROVAL
—	DRAWING RELEASE	11-14-02	DM
A	NOTE REVISIONS	4-16-04	DM
B	NOTE REVISIONS	6-17-09	CS

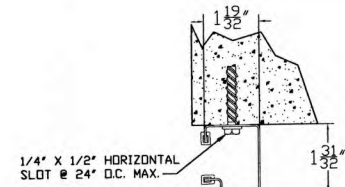

CONCRETE/FILLED BLOCK JAMBS  
USING 1/4" X 1-3/4" POWERS WEDGE-BOLT

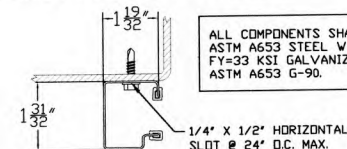

STEEL JAMBS  
USING 1/4-14 X 1" TEKS  
18 GA (.046) GUIDE MOUNTING DETAIL

ALL COMPONENTS SHALL BE  
ASTM A653 STEEL W/MIN  
FY=33 KSI GALVANIZED PER  
ASTM A653 G-90.

HEADROOM REQUIRED

OPENING HEIGHT	VERTICAL HEADROOM	HORIZONTAL HEADROOM
THRU 7'-4"	15-1/2"	17-1/2"
OVER 7'-4" THRU 8'-8"	16"	18"
OVER 8'-8" THRU 10'-0"	17"	18-1/4"

SEE SHEET 2 FOR NOTES

THESE CONFIDENTIAL DOCUMENTS SUBMITTED BY JANUS CONTAIN INFORMATION OF A PROPRIETARY NATURE AND MAY NOT BE REPRODUCED OR USED TO MANUFACTURE ANYTHING IN PART OR IN WHOLE FOR ANY PURPOSE OTHER THAN THAT WHICH IS NECESSARY FOR PREPARATION OF BIDS OF ENGINEERING WITHOUT THE EXPRESS PERMISSION OF JANUS WHICH MAY RECALL DOCUMENTS AT ANY TIME.

UNLESS OTHERWISE SPECIFIED DIMENSIONS ARE IN INCHES AND TOLERANCES ARE:

DECIMAL	FRACTIONS	ANGLES	HOLE DIAMETERS
.XX ±.03	± 1/16	± 0° 30'	UNDER .251 +.004 -.003
.XXX ±.005			.251 to .500 +.006 -.003
			OVER .500 +.008 -.003

PART NUMBER:	
MATERIAL:	
APPLIED FINISH:	
UNIT OF MEASURE:	
APPROVALS	DATE
DRAWN: BECKY NELSON	11-14-02
CHECKED: DON MILLS	11-14-02
APPROVED: DON MILLS	11-14-02

**JANUS INTERNATIONAL CORPORATION**  
134 JANUS INTERNATIONAL BLVD TEMPLE, GA 30179  
770-562-2850/Fax 770-562-2264  
© 2012 Janus International Corporation All Rights Reserved

CERTIFIED WIND LOAD RATED  
26 GA SERIES 750 DOOR ASSEMBLY  
MAX. SIZE 6'-0" X 12'-0"

SIZE <b>B</b>	DRAWING NUMBER T1001	REV. B
SCALE NONE	SHEET 1	OF 2

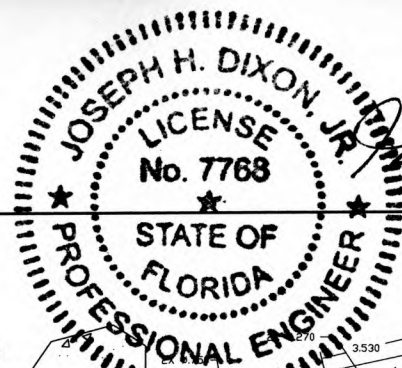

REVISIONS			
REV	DESCRIPTION	DATE	APPROVAL
—	DRAWING RELEASE	11-14-02	DM
A	NOTE REVISIONS	4-16-04	DM
B	NOTE REVISIONS	6-17-09	CS

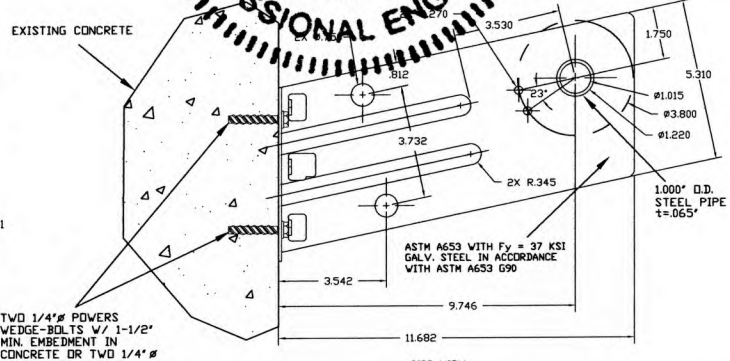
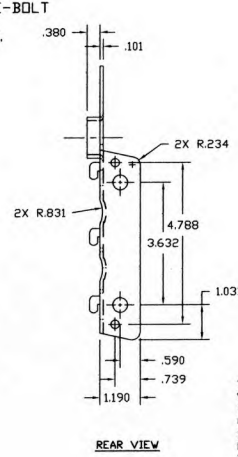
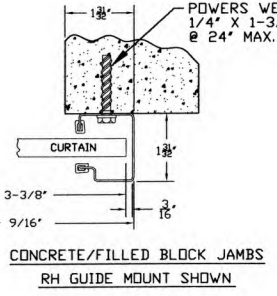
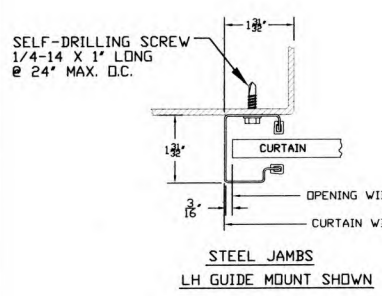

TWO 1/4" PIVERS WEDGE-BOLTS W/ 1-1/2" MIN. EMBEDMENT IN CONCRETE OR TWO 1/4" STEEL SCREWS W/ FULL PENETRATION INTO MIN. 1/8" STEEL IF EXISTING IS MASONRY. FILL CELL W/ 2500 PSI GROUT.

DOOR MOUNTING BRACKET DETAIL

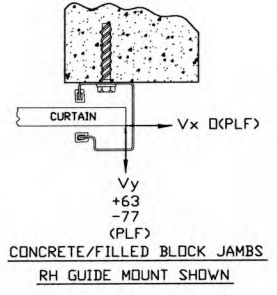
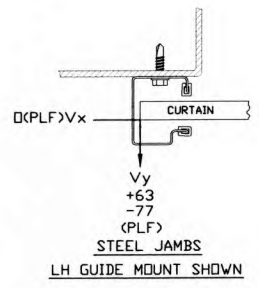

SUPERIMPOSED LOAD DIAGRAM

Comparative forces by calculation to determine maximum design pressure based on maximum moment and shear developed by test, 6' X 8' door

	Design Windload		Positive Wind Design		Negative Wind Design	
	Pos psf	Neg psf	Moment in-lb/ft	Shear lb/ft	Moment in-lb/ft	Shear lb/ft
Test Door 6' x 8'	19.9	24.4				
Calibration calculations for test door			1089.6	60.1	1336.0	73.7
Max Door Size (Width x Height)						
3'-4" x 12"	35.6	43.7	608.7	60.1	746.3	73.7
3'-6" x 12"	33.9	41.6	638.7	60.1	783.2	73.7
3'-8" x 12"	32.4	39.8	668.8	60.1	820.0	73.7
4'-0" x 12"	29.7	36.5	728.9	60.1	893.7	73.7
5'-0" x 12"	23.8	29.2	909.2	60.1	1114.8	73.7
5'-6" x 12"	21.7	26.6	999.4	60.1	1225.4	73.7
6'-0" x 12"	19.9	24.4	1089.6	60.1	1336.0	73.7

Design wind forces are calculated to produce moment and shear equal to or less than those developed in the test door. This indicates that the curtain, guides, and jamb anchorages will all be stressed to approximately the same or less than those in the test door, provided that the door is constructed the same for all opening widths.

GENERAL NOTES

- THIS ROLL-UP DOOR SYSTEM IS DESIGNED IN ACCORDANCE WITH THE FLORIDA BUILDING CODE.
- THIS ROLL-UP DOOR HAS BEEN TESTED IN ACCORDANCE WITH ASTM E-330 AND COMPLIES WITH ANSI/DASMA 108.  
DESIGN LOAD = +19.9 PSF  
= -24.4
- WIND LOADS FOR BUILDING OPENINGS SHALL BE DETERMINED BY A PROFESSIONAL ENGINEER USING APPROPRIATE WIND SPEED AND DESIGN CRITERIA. THIS DOOR MAY BE USED WHERE THE DESIGN LOAD MEETS OR EXCEEDS THE DESIGN LOAD FOR THE BUILDING OPENING.
- SUPERIMPOSED LOADS ON THE JAMBS FROM THIS DOOR ARE DESIGNED AS Vx AND Vy HEREIN. CONTRACTORS SHALL HAVE BUILDING ENGINEER VERIFY ADEQUACY OF BUILDING STRUCTURE TO RESIST SUPERIMPOSED LOADS Vx, Vy AND BRACKET LOADS SHOWN.
- ALL WELDING SHALL BE PERFORMED BY QUALIFIED WELDERS IN ACCORDANCE WITH A.W.S. SPECIFICATIONS, LATEST EDITION. ALL WELDING ELECTRODES SHALL CONFORM TO A.W.S. A5.1 GRADE E-70.
- DOORS SHALL BE PROVIDED WITH LOCK MECHANISMS AT THE OPTION OF THE OWNER.
- ALL BOLTS AND WASHERS SHALL BE GALVANIZED OR STAINLESS STEEL WITH A MINIMUM TENSILE STRENGTH OF 60 KSI.
- DESIGN BASED ON CERTIFIED TESTING LABORATORIES, INC., TEST REPORT NO. CTLA-983W-1

- ANCHOR NOTES:  
A. EMBEDMENT LENGTH DOES NOT INCLUDE STUCCO FINISH.  
B. FOR HOLLOW MASONRY, FILL ALL CELLS @ ANCHOR WITH 2500 PSI GROUT.  
C. ANCHORS SHALL BE INSTALLED IN ACCORDANCE WITH MANUFACTURER'S SPECIFICATIONS.
- DOOR OPERATION TYPE TO BE PUSH-UP.
- GUIDE TO JAMB ATTACHMENT FASTENERS BEGIN 4' FROM FLOOR AND END 3-1/2' BELOW TOP OF WALL OPENING.
- TEST DOOR WALL OPENING SIZE: 6'-0" x 8'-0".

THESE CONFIDENTIAL DOCUMENTS SUBMITTED BY JANUS CONTAIN INFORMATION OF A PROPRIETARY NATURE AND MAY NOT BE REPRODUCED OR USED TO MANUFACTURE ANYTHING IN PART OR IN WHOLE FOR ANY PURPOSE OTHER THAN THAT WHICH IS NECESSARY FOR PREPARATION OF BIDS OF ENGINEERING WITHOUT THE EXPRESS PERMISSION OF JANUS WHICH MAY RECALL DOCUMENTS AT ANY TIME.

UNLESS OTHERWISE SPECIFIED DIMENSIONS ARE IN INCHES AND TOLERANCES ARE:

DECIMAL	FRACTIONS	ANGLES	HOLE DIAMETERS
.XX ±.03	± 1/16	± 0° 30'	UNDER .251 +.004 -.003
.XXX ±.005			.251 to .500 +.006 -.003
			OVER .500 +.008 -.003

PART NUMBER:	
MATERIAL:	
APPLIED FINISH:	
UNIT OF MEASURE:	
APPROVALS	DATE
DRAWN BY: BECKY NELSON	11-14-02
CHECKED BY: DON MILLS	11-14-02
APPROVED BY: DON MILLS	11-14-02

**JANUS INTERNATIONAL CORPORATION**  
 134 JANUS INTERNATIONAL BLVD TEMPLE, GA 30179  
 770-562-2850/Fax 770-562-2264  
 © 2012 Janus International Corporation All Rights Reserved

CERTIFIED WIND LOAD RATED  
 26 GA SERIES 750 DOOR ASSEMBLY  
 MAX. SIZE 6'-0" X 12'-0"

SIZE: DRAWING NUMBER: **T1001** REV: **B**

SCALE: NONE SHEET: 2 OF: 2

June 22, 2009  
Rev. 02/15/12

**EVALUATION REPORT No.:** ER-09-0007-R

**Reference No.:** 29018\_32003

**Product:** Exterior Doors - Rolling Overhead Doors  
Series 750, Series 3100, Series 850-S

**Manufacturer:** Janus International Corporation  
134 Janus International Blvd.  
Temple, GA 30179-4435

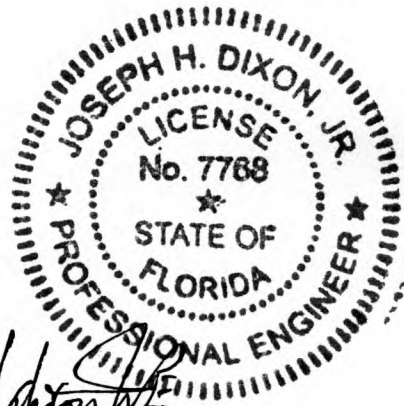

**Statement of Compliance:**

The Rolling Doors, Series 750 and Series 3100 described in this report were evaluated to be in compliance with the 2010 Florida Building Code. Series 850-S was evaluated to be in compliance with the 2010 Florida Building Code "High Velocity Hurricane Zones" Sections in Chapters 16 and 17, and may be considered impact resistant. The doors are, for the purpose intended, at least equivalent to that required by the Code when manufactured and installed as described below.

**Description of the Product:**

All doors consist of a corrugated steel sheet curtain suspended from a drum roller. The curtain on all models is suspended from a drum roller. Coiling around the drum raises the curtain. The sides of the curtain are constrained from lateral movement along their vertical edges by steel guides that are attached to the door jambs. This constraint provides resistance to lateral wind forces. Various guide configurations are used for the different door styles included in this report. The lateral wind forces are transferred from the curtain to the guides and then through the attachment elements to the door jamb. The door jambs are part of the main wind frame resisting system and usually are constructed of steel, concrete, or concrete masonry units.

Series 750 (Mini Door)

Door curtains have a thickness of 26 gage (min. 0.017 in.) and are made of ASTM A653 structural steel, grade 80, pre-painted, galvanized steel with a full coat of primer and baked siliconized polyester finish coat. The corrugated sheets are interlocked mechanically to form the curtain. Lap splices are at approximately 20 inches on center vertically in the installed door. The corrugation height is approximately 5/8 inches and the corrugation pitch is 3.25 in. Style variations include door width, windlocks, and wind load rating. Maximum door height is limited to 12'-0". Various door widths are described in detail on drawings T1000 (3'-0" wide), T1001 (6'-0" wide), T1002 (8'-8" wide) and T1003 (10'-0" wide). Tests were conducted on each of the four width doors shown on these drawings. A comparative analysis was used to determine the design pressures on doors between 3'-0" and 6'-0" wide. Doors greater than 6'-0" wide having opening widths between those shown on drawings T1001, T1002, and T1003 may be used for the same design wind pressure as

the next larger width door provided all other requirements on the larger width door drawing remain unchanged. Doors shown on drawings T1000 and T1001 do not have windlocks. Doors shown on drawings T1002 and T1003 have windlocks. The guide geometry and attachment method is fully described on the drawings.

### Series 3100 (Commercial Door)

Door curtains have a thickness of 26 gage (min. 0.017 in.) and are made of ASTM A653 structural steel, grade 80, pre-painted, galvanized steel with a full coat of primer and baked siliconized polyester finish coat. The corrugated sheets are interlocked mechanically to form the curtain. Lap splices are at approximately 20 inches on center vertically in the installed door. The corrugation height is approximately 5/8 inches and the corrugation pitch is 3.25 in. Style variations include door width, and wind load rating. Maximum door height is limited to 20'-0". Two door widths are described in detail on drawings T1004 (12'-0" wide), and T1005 (16'-0" wide). Two complete tests were conducted on each of these two width doors. One test used the Option 1 Guide and the other used the Option 2 Guide for attachment to the steel jamb. Doors having opening widths less than 12'-0" may be used for the same design wind pressure as the 12'-0" wide door provided all other requirements on that drawing remain unchanged. Doors having opening widths less than 16'-0" may be used for the same design wind pressure as the 16'-0" wide door provided all other requirements on that drawing remain unchanged. All doors shown on drawings T1004 and T1005 have windlocks.

### Series 850-S (Florida State Mini Door) Impact Resistant

Door curtains may have a thickness of either 24 gage (min. 0.022 in.) or 26 gage (min. 0.017 in.). The curtain steel is ASTM A653 structural steel, grade 80, pre-painted, galvanized steel with a full coat of primer and baked siliconized polyester finish coat. The corrugated sheets are interlocked mechanically to form the curtain. Lap splices are at approximately 20 inches on center vertically in the installed door. The corrugation height is approximately 5/8 inches and the corrugation pitch is 3.25 inches. Maximum door height is limited to 12'-0". Only the 8'-8" wide door is qualified as impact resistant and it is described in detail on drawing T1006-S. Doors having opening widths less than 8'-8" may be used for the same design wind pressure as the 8'-8" wide door provided all other requirements on that drawing remain unchanged. The door shown on drawing T1006-S has windlocks. Tests in accordance with Florida Building Code Test Protocols TAS 201, TAS 202, and TAS 203 were conducted on this door.

### All Series

Maximum door widths and heights are shown in Table 1. The pressures shown in Table 1 are the maximum allowable design wind load values. These design pressures may be used for narrower width doors of the same Series provided all other requirements of the wider door remain unchanged.

### Drawings

The Door Series covered by this report are described in detail on the following Janus International Corporation drawings:

- Drawing T1000: 3'-0" wide max. x 12'-0" high max., shts 1 and 2 of 2, revised 06/17/09 ©2012
- Drawing T1001: 6'-0" wide max. x 12'-0" high max., shts 1 and 2 of 2, revised 06/17/09 ©2012
- Drawing T1002: 8'-8" wide max. x 12'-0" high max., shts 1 and 2 of 2, revised 06/17/09 ©2012
- Drawing T1003: 10'-0" wide max. x 12'-0" high max., shts 1 and 2 of 2, revised 06/17/09 ©2012
- Drawing T1004: 12'-0" wide max. x 20'-0" high max., shts 1 and 2 of 2, revised 01/20/12 ©2012
- Drawing T1005: 16'-0" wide max. x 20'-0" high max., shts 1 and 2 of 2, revised 01/20/12 ©2012
- Drawing T1006-S: 8'-8" wide max. x 12'-0" high max., shts 1 and 2 of 2, revised 06/17/09 ©2012

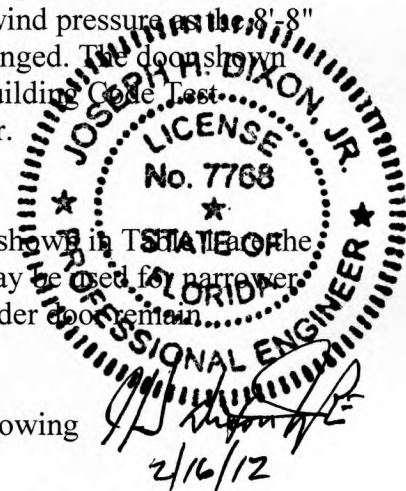

## Technical Documentation:

All testing was done at Certified Testing Laboratories, Orlando, Florida. Tests for Series 750 and Series 3100 were conducted following the procedures of ASTM E330, Structural Performance of Exterior Windows, Curtain Walls, and Doors by Uniform Static Air Pressure Difference. The following test reports, signed and sealed by R. Patel, P.E. cover the Series 750 and Series 3100 doors contained in this report:

- Test Report No.: CTLA-983W, date: November 7, 2002, (Series 750, T1000), 3'-0" wide x 8'-0" high, +35 / -45 psf design pressure
- Test Report No.: CTLA-983W-1, date: November 7, 2002, (Series 750, T1001), 6'-0" wide x 8'-0" high, +19.9 / -24.4 psf design pressure
- Test Report No.: CTLA-983W-2, date: December 2, 2002, (Series 750, T1002), 8'-8" wide x 8'-0" high, +24.4 / -27.0 psf design pressure
- Test Report No.: CTLA-983W-3, date: November 7, 2002, (Series 750, T1003), 10'-0" wide x 8'-0" high, +19.4 / -22.7 psf design pressure
- Test Report No.: CTLA-1024W, date: February 20, 2003, (Series 3100, T1004) 12'-0" wide x 8'-0" high, +36.0 / -41.0 psf design pressure
- Test Report No.: CTLA-1194W, date: December 2, 2003, (Series 3100, T1004) 12'-0" wide x 8'-0" high, +36.0 / -41.0 psf design pressure, (Option 1 guide for steel)
- Test Report No.: CTLA-1432W, date: November 3, 2005, (Series 3100, T1005) 16'-0" wide x 8'-0" high, +35.0 / -38.0 psf design pressure
- Test Report No.: CTLA-1432W-1, date: November 3, 2005, (Series 3100, T1005) 16'-0" wide x 8'-0" high, +35.0 / -38.0 psf design pressure, (Option 1 guide for steel)

Calculations prepared by Joseph H. Dixon, Jr. P.E.:

- Series 750, no windlocks, Summary of Design Wind Pressures based on comparative analysis for doors 3'-4" to 5'-6" wide, 1 page, revised 4/10/04.
- Series 3100, dwg. T1004, attachment of guide, Option 3, to 14 gage minimum steel jamb thickness, 6 pages dated 6/18/09, plus drawing JI-3100G1-2SP and drawing JI-3100G1-2SN, both dated 4/07/04.
- Series 750 and 3100 verification of compliance with ANSI/DASMA 108

## Impact Resistant Doors

Tests for Series 850-S were conducted following the procedures of the Florida Building Code Test Protocols TAS 201, TAS 202, and TAS 203. The following test reports, signed and sealed by R. Patel, P.E. cover the Series 850-S doors contained in this report:

- Test Report No.: CTLA-1115W, date: August 20, 2003, (Series 850-S, T1006 S) 8'-8" wide x 8'-0" high, +46 / -54 psf design pressure

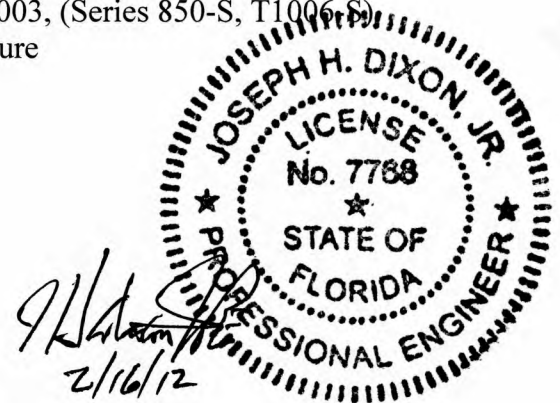

**TABLE 1**  
**Allowable Transverse Design Wind Loads (psf)**

Series	Max. Door Width	Max. Door Height	Drawing Number	Design Load Positive	Design Load Negative
750	3'-0"	12'-0"	T1000	35.0	45.0
750	3'-4"	12'-0"	T1001	35.6	43.7
750	3'-6"	12'-0"	T1001	33.9	41.6
750	3'-8"	12'-0"	T1001	32.4	39.8
750	4'-0"	12'-0"	T1001	29.7	36.5
750	5'-0"	12'-0"	T1001	23.8	29.2
750	5'-6"	12'-0"	T1001	21.7	26.6
750	6'-0"	12'-0"	T1001	19.9	24.4
750	8'-8"	12'-0"	T1002	24.4	27.0
750	10'-0"	12'-0"	T1003	19.4	22.7
3100	12'-0"	20'-0"	T1004	36.0	41.0
3100	16'-0"	20'-0"	T1005	35.0	38.0
850-S	8'-8"	12'-0"	T1006-S	46.0	54.0

Design values used for the tests are shown in the boxed shaded values.

Maximum test load was 150% of design load.

Unshaded design wind loads were determined by comparative analyses using test results.

### Installation Requirements:

Installation requirements are described in the Janus International Corporation Installation Instructions as follows:

- Series 750: 4 pages, Mini Door Installation Instructions Series 750
- Series 3100: 8 pages, Commercial Door Installation Instructions Series 3100
- Series 850: 4 pages, Mini Door Installation Instructions Series 850

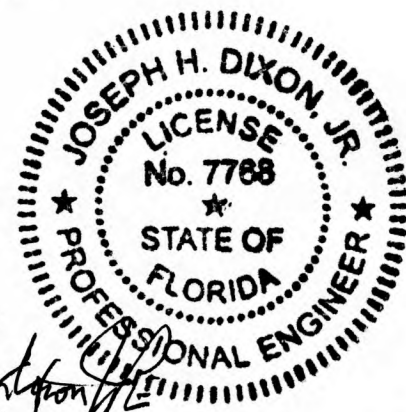

*JH Dixon*  
2/16/12

**Limitations and Conditions of use:**

The use of any door is limited to buildings for which the design wind loads for wall components and cladding, determined in accordance with Section 1609 of the 2010 Florida Building Code, do not exceed the rated design wind loads of the door as shown in Table 1.

Series 850-S is qualified as impact resistant. This door has been tested and met the additional requirements of Sections 1625 and 1626 of the 2010 Florida Building Code.

The maximum width and height limitations for each Series are shown in Table 1.

Doors are to be assembled as shown on the appropriate drawing referenced above, and the doors are to be installed in accordance with the installation instructions referenced above.

Door manufacturing is limited to those plants that have met the 2010 Florida Building Code Product Approval quality assurance requirements.

The doors covered by this report are not for use in the Florida High-Velocity Hurricane Zone.

**Certification of Independence:**

I, Joseph H. Dixon, Jr., certify that I am self-employed and operate as an independent contractor providing professional engineering services. I have no financial interest in nor will I acquire any financial interest in any company manufacturing or distributing products for which evaluation or validation reports have been issued by me.

Likewise, I have no financial interest in nor will I acquire any financial interest in any other entity involved in the approval process of those products for which I have issued reports.



Joseph H. Dixon, Jr. P.E.

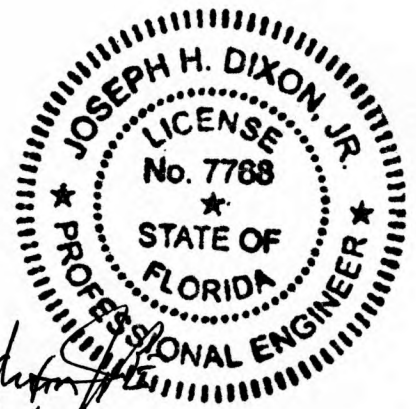

Handwritten signature and date: JH Dixon, Jr. 2/16/12